

# SOAP DISPENSERS

---

# 59-84



TRENDY  
SOAP DISPENSERS **61**



EXTREME  
SOAP DISPENSERS **63**



ELITE  
SOAP DISPENSERS **65**



GREEN  
SOAP DISPENSERS **67**



GREEN 28  
SOAP DISPENSERS **69**



SWAN  
SOAP DISPENSERS **71**



TUBULAR  
SOAP DISPENSERS **73**



QUADRAT  
SOAP DISPENSERS **75**



BEHIND MIRROR  
SOAP DISPENSER **77**



TUBULAR FOAM  
SOAP DISPENSER **78**



LAVATORY FOAM  
SOAP DISPENSERS **79**



MULTIFEED KITS  
& OPTIONS **81**

# TRENDY SOAP DISPENSER

DECK MOUNTED TOUCH FREE ELECTRONIC SOAP DISPENSER FOR LIQUID NON-PROPRIETARY SOAP

Series includes options for:

Individual one (1) liter bottle.

Individual five (5) liter tank.

Versions to accommodate multiple soap dispensers installation (up to 6 dispensers simultaneously) with five (5) liters tank.

Tall versions for counter top sinks.



Advantages:

- Drastically reduces soap consumption
- No physical contact. Helps to protect users against cross contamination.
- Peristaltic pump. The soap is driven inside the soap tube without contact with the pump, preventing contamination and back flow.
- Accurate soap dosage
- To be used with non-proprietary soap for maximum savings.
- Soap dosage adjustable by remote control
- Easy to install and refill
- Matching IR operated faucet



## SOAP DISPENSER VERSIONS

PICTURE	PRODUCT NAME	MODEL FEATURES	POWER SUPPLY	CODE NUMBER	DRAWING
---------	--------------	----------------	--------------	-------------	---------

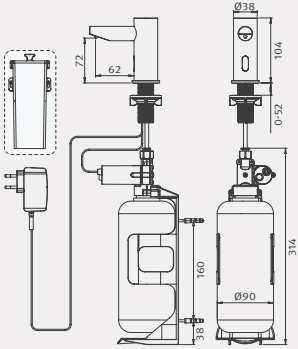
	<b>TRENDY SOAP DISPENSER B</b>	Standard	Battery box for 6D batteries	<b>239910</b>	
	<b>TRENDY SOAP DISPENSER E</b>		12V Transformer	<b>239900</b>	

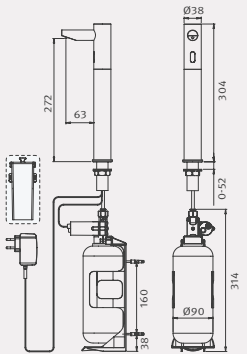
	<b>TRENDY SOAP DISPENSER PLUS B</b>	Tall version 304 mm body	Battery box for 6D batteries	<b>239912</b>	
	<b>TRENDY SOAP DISPENSER PLUS E</b>		12V Transformer	<b>239902</b>	

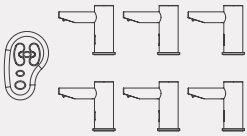

## 6-PACK SOAP DISPENSER VERSIONS

PRODUCT NAME	MODEL FEATURES	POWER SUPPLY	CODE NUMBER	DRAWING
--------------	----------------	--------------	-------------	---------

<b>TRENDY SD B 6-PACK</b>	Packaging includes 6 individual soap dispenser units and 1 remote control	Battery box for 6D batteries	<b>239911</b>	
<b>TRENDY SD E 6-PACK</b>		12V Transformer	<b>239902</b>	

## SOAP DISPENSER ACCESSORIES

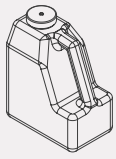
PRODUCT NAME	MODEL FEATURES	CODE NUMBER	DRAWING
--------------	----------------	-------------	---------

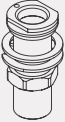
<b>5L TANK KIT for individual soap dispenser</b>	5 liters tank kit to be used with an individual soap dispenser. Ideal for locations with only one soap dispenser and non frequent servicing	<b>07220097</b>	
<b>REMOTE CONTROL FOR SD</b>	Allows changing: soap quantity, temporary off function, back to soap factory settings, refill the soap tank	<b>07100008</b>	
<b>HEAVY DUTY BRASS BASE KIT (For extra robustness)</b>	Optional brass base for high traffic public locations	<b>07246036</b>	

# EXTREME SOAP DISPENSER

DECK MOUNTED TOUCH FREE ELECTRONIC SOAP DISPENSER FOR LIQUID NON-PROPRIETARY SOAP

Series includes options for:

Individual one (1) liter bottle.

Individual five (5) liter tank.

Versions to accommodate multiple soap dispensers installation (up to 6 dispensers simultaneously) with five (5) liters tank.

Tall versions for counter top sinks.

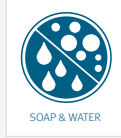



Advantages:

- Drastically reduces soap consumption
- No physical contact. Helps to protect users against cross contamination.
- Peristaltic pump. The soap is driven inside the soap tube without contact with the pump, preventing contamination and back flow.
- Accurate soap dosage
- To be used with non-proprietary soap for maximum savings.
- Soap dosage adjustable by remote control
- Easy to install and refill
- Matching IR operated faucet

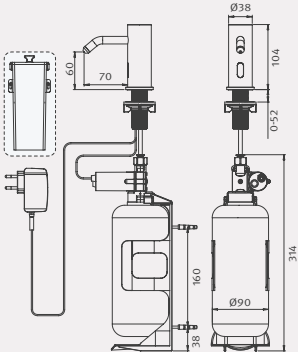

## SOAP DISPENSER VERSIONS

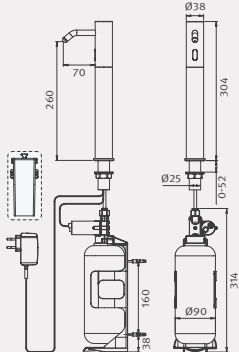

PICTURE	PRODUCT NAME	MODEL FEATURES	POWER SUPPLY	CODE NUMBER	DRAWING
	<b>EXTREME SOAP DISPENSER B</b>	Standard	Battery box for 6D batteries	<b>237920</b>	
	<b>EXTREME SOAP DISPENSER E</b>		12V Transformer	<b>237900</b>	

	<b>EXTREME SOAP DISPENSER PLUS B</b>	Tall version 304 mm body	Battery box for 6D batteries	<b>237922</b>	
	<b>EXTREME SOAP DISPENSER PLUS E</b>		12V Transformer	<b>237905</b>	

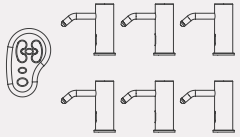
## 6-PACK SOAP DISPENSER VERSIONS

PRODUCT NAME	MODEL FEATURES	POWER SUPPLY	CODE NUMBER	DRAWING
<b>EXTREME SD B 6-PACK</b>	Packaging includes 6 individual soap dispenser units and 1 remote control	Battery box for 6D batteries	<b>237921</b>	
<b>EXTREME SD E 6-PACK</b>		12V Transformer	<b>237901</b>	

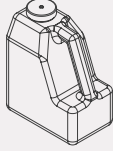
## SOAP DISPENSER ACCESSORIES

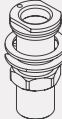
PRODUCT NAME	MODEL FEATURES	CODE NUMBER	DRAWING
<b>5L TANK KIT for individual soap dispenser</b>	5 liters tank kit to be used with an individual soap dispenser. Ideal for locations with only one soap dispenser and non frequent servicing	<b>07220097</b>	
<b>REMOTE CONTROL FOR SD</b>	Allows changing: soap quantity, temporary off function, back to soap factory settings, refill the soap tank	<b>07100008</b>	
<b>HEAVY DUTY BRASS BASE KIT (For extra robustness)</b>	Optional brass base for high traffic public locations	<b>07246036</b>	

# ELITE SOAP DISPENSER

DECK MOUNTED TOUCH FREE ELECTRONIC SOAP DISPENSER FOR LIQUID NON-PROPRIETARY SOAP

Series includes options for:

Individual one (1) liter bottle.

Individual five (5) liter tank.

Versions to accommodate multiple soap dispensers installation (up to 6 dispensers simultaneously) with five (5) liters tank.

Tall versions for counter top sinks.

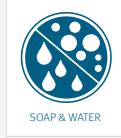

Advantages:

- Drastically reduces soap consumption
- No physical contact. Helps to protect users against cross contamination.
- Peristaltic pump. The soap is driven inside the soap tube without contact with the pump, preventing contamination and back flow.
- Accurate soap dosage
- To be used with non-proprietary soap for maximum savings.
- Soap dosage adjustable by remote control
- Easy to install and refill
- Matching IR operated faucet



## SOAP DISPENSER VERSIONS

PICTURE	PRODUCT NAME	MODEL FEATURES	POWER SUPPLY	CODE NUMBER	DRAWING
---------	--------------	----------------	--------------	-------------	---------

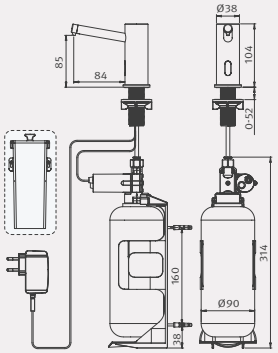
	<b>ELITE SOAP DISPENSER B</b>	Standard	Battery box for 6D batteries	<b>236110</b>	
	<b>ELITE SOAP DISPENSER E</b>		12V Transformer	<b>236100</b>	

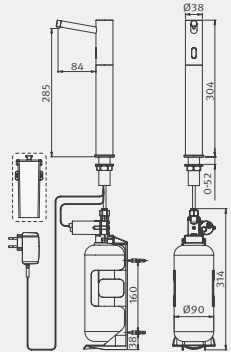
	<b>ELITE SOAP DISPENSER PLUS B</b>	Tall version 304 mm body	Battery box for 6D batteries	<b>236107</b>	
	<b>ELITE SOAP DISPENSER PLUS E</b>		12V Transformer	<b>236105</b>	

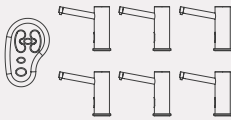

## 6-PACK SOAP DISPENSER VERSIONS

PRODUCT NAME	MODEL FEATURES	POWER SUPPLY	CODE NUMBER	DRAWING
--------------	----------------	--------------	-------------	---------

<b>ELITE SD B 6-PACK</b>	Packaging includes 6 individual soap dispenser units and 1 remote control	Battery box for 6D batteries	<b>236111</b>	
<b>ELITE SD E 6-PACK</b>		12V Transformer	<b>236101</b>	

## SOAP DISPENSER ACCESSORIES

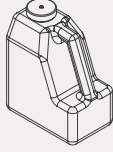
PRODUCT NAME	MODEL FEATURES	CODE NUMBER	DRAWING
--------------	----------------	-------------	---------

<b>5L TANK KIT for individual soap dispenser</b>	5 liters tank kit to be used with an individual soap dispenser. Ideal for locations with only one soap dispenser and non frequent servicing	<b>07220097</b>	
<b>REMOTE CONTROL FOR SD</b>	Allows changing: soap quantity, temporary off function, back to soap factory settings, refill the soap tank	<b>07100008</b>	
<b>HEAVY DUTY BRASS BASE KIT (For extra robustness)</b>	Optional brass base for high traffic public locations	<b>07246036</b>	



# GREEN SOAP DISPENSER

DECK MOUNTED TOUCH FREE ELECTRONIC SOAP DISPENSER FOR LIQUID NON-PROPRIETARY SOAP

Series includes options for:

Individual one (1) liter bottle.

Individual five (5) liter tank.

Versions to accommodate multiple soap dispensers installation (up to 6 dispenser simultaneously) with five (5) liters tank.

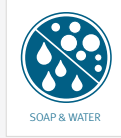

Advantages:

- Drastically reduces soap consumption
- No physical contact. Helps to protect users against cross contamination.
- Peristaltic pump. The soap is driven inside the soap tube without contact with the pump, preventing contamination and back flow.
- Accurate soap dosage
- To be used with non-proprietary soap for maximum savings.
- Soap dosage adjustable by remote control
- Easy to install and refill
- Matching IR operated faucet

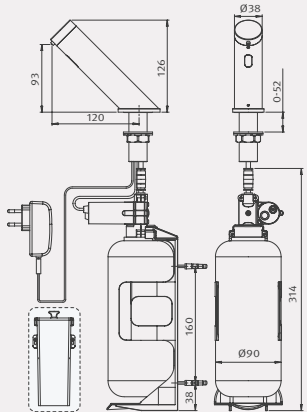

## SOAP DISPENSER VERSIONS

PICTURE	PRODUCT NAME	MODEL FEATURES	POWER SUPPLY	CODE NUMBER	DRAWING
	<b>GREEN SOAP DISPENSER B</b>	Includes a brass basis for highly abused (high traffic) locations	Battery box for 6D batteries	<b>225845</b>	
	<b>GREEN SOAP DISPENSER E</b>		12V Transformer	<b>225840</b>	

## 6-PACK SOAP DISPENSER VERSIONS

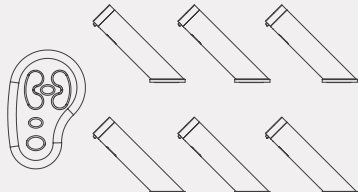
PRODUCT NAME	MODEL FEATURES	POWER SUPPLY	CODE NUMBER	DRAWING
<b>GREEN SD B 6-PACK</b>	Packaging includes 6 individual soap dispenser units and 1 remote control	Battery box for 6D batteries	<b>225846</b>	
<b>GREEN SD E 6-PACK</b>		12V Transformer	<b>225841</b>	

## SOAP DISPENSER ACCESSORIES

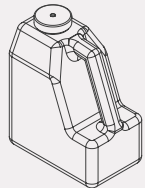
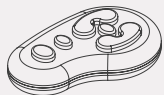
PRODUCT NAME	MODEL FEATURES	CODE NUMBER	DRAWING
<b>5L TANK KIT for individual soap dispenser</b>	5 liters tank kit to be used with an individual soap dispenser. Ideal for locations with only one soap dispenser and non frequent servicing	<b>07220097</b>	
<b>REMOTE CONTROL FOR SD</b>	Allows changing: soap quantity, temporary off function, back to soap factory settings, refill the soap tank	<b>07100008</b>	

# GREEN 28 SOAP DISPENSER

DECK MOUNTED TOUCH FREE ELECTRONIC SOAP DISPENSER FOR LIQUID NON-PROPRIETARY SOAP

Series includes options for:

Individual one (1) liter bottle.

Individual five (5) liter tank.

Versions to accommodate multiple soap dispensers installation (up to 6 dispenser simultaneously) with five (5) liters tank.

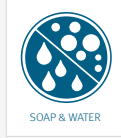

Advantages:

- Drastically reduces soap consumption
- No physical contact. Helps to protect users against cross contamination.
- Peristaltic pump. The soap is driven inside the soap tube without contact with the pump, preventing contamination and back flow.
- Accurate soap dosage
- To be used with non-proprietary soap for maximum savings.
- Soap dosage adjustable by remote control
- Easy to install and refill
- Matching IR operated faucet



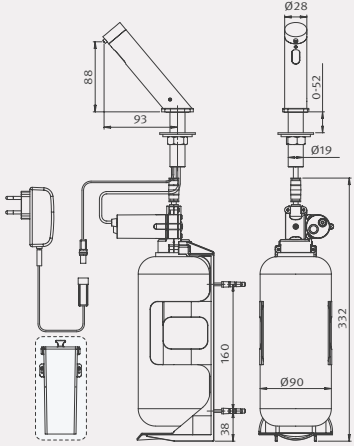

## SOAP DISPENSER VERSIONS

PICTURE	PRODUCT NAME	MODEL FEATURES	POWER SUPPLY	CODE NUMBER	DRAWING
	<b>GREEN 28 SOAP DISPENSER B</b>	Includes a brass basis for highly abused (high traffic) locations	Battery box for 6D batteries	<b>352900</b>	
	<b>GREEN 28 SOAP DISPENSER E</b>		12V Transformer	<b>352910</b>	

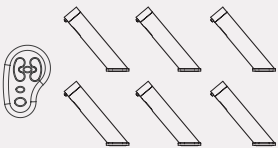
## 6-PACK SOAP DISPENSER VERSIONS

PRODUCT NAME	MODEL FEATURES	POWER SUPPLY	CODE NUMBER	DRAWING
<b>GREEN SD B 6-PACK</b>	Packaging includes 6 individual soap dispenser units and 1 remote control	Battery box for 6D batteries	<b>352901</b>	
<b>GREEN SD E 6-PACK</b>		12V Transformer	<b>352911</b>	

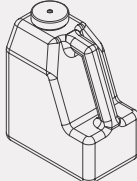
## SOAP DISPENSER ACCESSORIES

PRODUCT NAME	MODEL FEATURES	CODE NUMBER	DRAWING
<b>5L TANK KIT for individual soap dispenser</b>	5 liters tank kit to be used with an individual soap dispenser. Ideal for locations with only one soap dispenser and non frequent servicing	<b>07220097</b>	
<b>REMOTE CONTROL FOR SD</b>	Allows changing: soap quantity, temporary off function, back to soap factory settings, refill the soap tank	<b>07100008</b>	

# SWAN SOAP DISPENSER

DECK MOUNTED TOUCH FREE ELECTRONIC SOAP DISPENSER FOR LIQUID NON-PROPRIETARY SOAP

Series includes options for:

Individual one (1) liter bottle.

Individual five (5) liter tank.

Versions to accommodate multiple soap dispensers installation (up to 6 dispenser simultaneously) with five (5) liters tank.

Tall versions for counter top sinks.

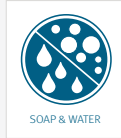

Advantages:

- Drastically reduces soap consumption
- No physical contact. Helps to protect users against cross contamination.
- Peristaltic pump. The soap is driven inside the soap tube without contact with the pump, preventing contamination and back flow.
- Accurate soap dosage
- To be used with non-proprietary soap for maximum savings.
- Soap dosage adjustable by remote control
- Easy to install and refill
- Matching IR operated faucet





## SOAP DISPENSER VERSIONS

PICTURE	PRODUCT NAME	MODEL FEATURES	POWER SUPPLY	CODE NUMBER	DRAWING
	<b>SWAN SOAP DISPENSER B</b>	Includes a brass basis for highly abused (high traffic) locations	Battery box for 6D batteries	<b>250920</b>	
	<b>SWAN SOAP DISPENSER E</b>		12V Transformer	<b>250910</b>	

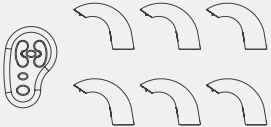
## 6-PACK SOAP DISPENSER VERSIONS

PRODUCT NAME	MODEL FEATURES	POWER SUPPLY	CODE NUMBER	DRAWING
<b>SWAN SD B 6-PACK</b>	Packaging includes 6 individual soap dispenser units and 1 remote control	Battery box for 6D batteries	<b>250921</b>	
<b>SWAN SD E 6-PACK</b>		12V Transformer	<b>250911</b>	

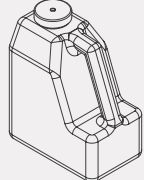
## SOAP DISPENSER ACCESSORIES

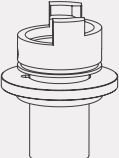
PRODUCT NAME	MODEL FEATURES	CODE NUMBER	DRAWING
<b>5L TANK KIT for individual soap dispenser</b>	5 liters tank kit to be used with an individual soap dispenser. Ideal for locations with only one soap dispenser and non frequent servicing	<b>07220097</b>	
<b>REMOTE CONTROL FOR SD</b>	Allows changing: soap quantity, temporary off function, back to soap factory settings, refill the soap tank	<b>07100008</b>	
<b>ANTI-ROTATION KIT</b>	Prevents rotation of the soap dispenser body due to vandalism	<b>07240059</b>	

# TUBULAR SOAP DISPENSER

WALL MOUNTED TOUCH FREE ELECTRONIC SOAP DISPENSER FOR LIQUID NON-PROPRIETARY SOAP

Series includes options for:

Individual one (1) liter bottle.

Individual five (5) liter tank.

Versions to accommodate multiple soap dispensers installation (up to 6 dispenser simultaneously) with five (5) liters tank.

Tall versions for counter top sinks.

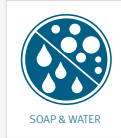



Advantages:

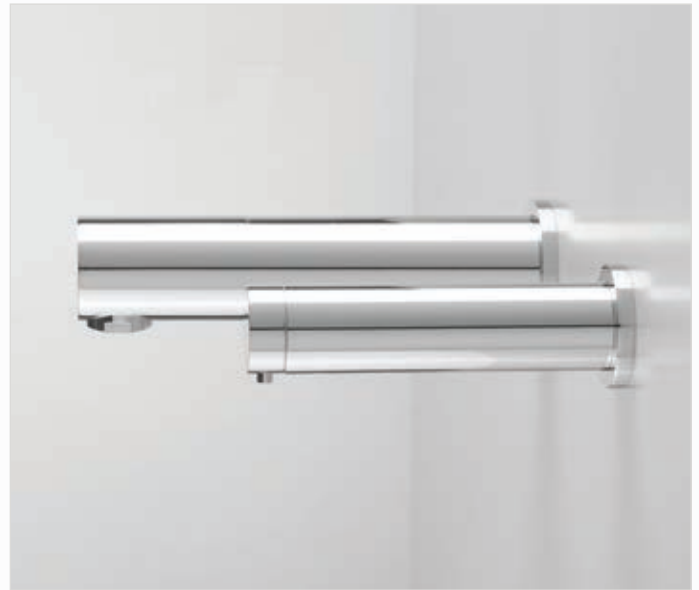

- Drastically reduces soap consumption
- No physical contact. Helps to protect users against cross contamination.
- Peristaltic pump. The soap is driven inside the soap tube without contact with the pump, preventing contamination and back flow.
- Accurate soap dosage
- To be used with non-proprietary soap for maximum savings.
- Soap dosage adjustable by remote control
- Easy to install and refill
- Matching IR operated faucet

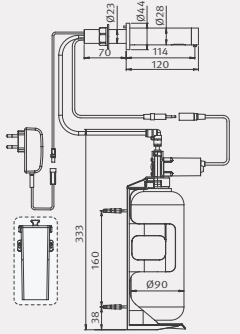

## SOAP DISPENSER VERSIONS

PICTURE	PRODUCT NAME	MODEL FEATURES	POWER SUPPLY	CODE NUMBER	DRAWING
	TUBULAR SOAP DISPENSER B	Standard. Option for a long 133 mm spout	Battery box for 6D batteries	350920	
	TUBULAR SOAP DISPENSER E		12V Transformer	350925	
	TUBULAR SOAP DISPENSER 2030 B	Concealed installation. Option for a long 133 mm spout	Battery box for 6D batteries	350922	
	TUBULAR SOAP DISPENSER 2030 E		12V Transformer	350927	

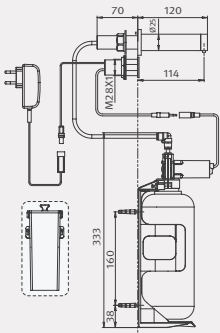
## SOAP DISPENSER VERSIONS

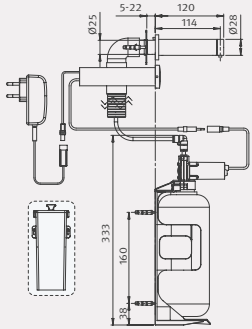
PICTURE	PRODUCT NAME	MODEL FEATURES	POWER SUPPLY	CODE NUMBER	DRAWING
	<b>TUBULAR PROX SOAP DISPENSER B</b>	With proximity sensor unit	Battery box for 6D batteries	<b>350930</b>	
	<b>TUBULAR PROX SOAP DISPENSER E</b>		12V Transformer	<b>350940</b>	
	<b>TUBULAR PROX SOAP DISPENSER 2030 B</b>	Concealed installation with proximity sensor unit	Battery box for 6D batteries	<b>350935</b>	
	<b>TUBULAR PROX SOAP DISPENSER 2030 E</b>		12V Transformer	<b>350945</b>	

## 6-PACK SOAP DISPENSER VERSIONS

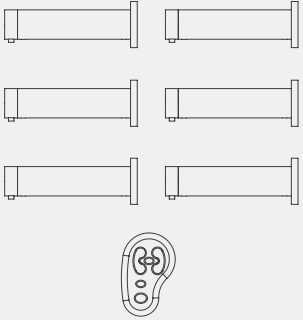
PRODUCT NAME	MODEL FEATURES	POWER SUPPLY	CODE NUMBER	DRAWING
<b>TUBULAR SD B 6-PACK</b>	Packaging includes 6 individual soap dispenser units and 1 remote control	Battery box for 6D batteries	<b>350921</b>	
<b>TUBULAR SD E 6-PACK</b>		12V Transformer	<b>350926</b>	
<b>TUBULAR 2030 SD B 6-PACK</b>		Battery box for 6D batteries	<b>350923</b>	
<b>TUBULAR 2030 SD E 6-PACK</b>		12V Transformer	<b>350928</b>	
<b>TUBULAR PROX SD 2030B 6-PACK</b>		Battery box for 6D batteries	<b>350936</b>	
<b>TUBULAR PROX SD 2030E 6-PACK</b>		12V Transformer	<b>350946</b>	

## SOAP DISPENSER ACCESSORIES

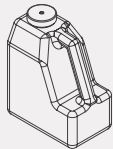
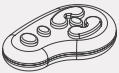
PRODUCT NAME	MODEL FEATURES	CODE NUMBER	DRAWING
<b>5L TANK KIT for individual soap dispenser</b>	5 liters tank kit to be used with an individual soap dispenser. Ideal for locations with only one soap dispenser and non frequent servicing	<b>07220097</b>	
<b>REMOTE CONTROL FOR SD</b>	Allows changing: soap quantity, temporary off function, back to soap factory settings, refill the soap tank	<b>07100008</b>	



# QUADRAT SOAP DISPENSER

WALL MOUNTED TOUCH FREE ELECTRONIC SOAP DISPENSER FOR LIQUID NON-PROPRIETARY SOAP

Series includes options for:

Individual one (1) liter bottle.

Individual five (5) liter tank.

Versions to accommodate multiple soap dispensers installation (up to 6 dispenser simultaneously) with five (5) liters tank.

Tall versions for counter top sinks.

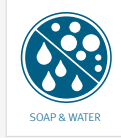

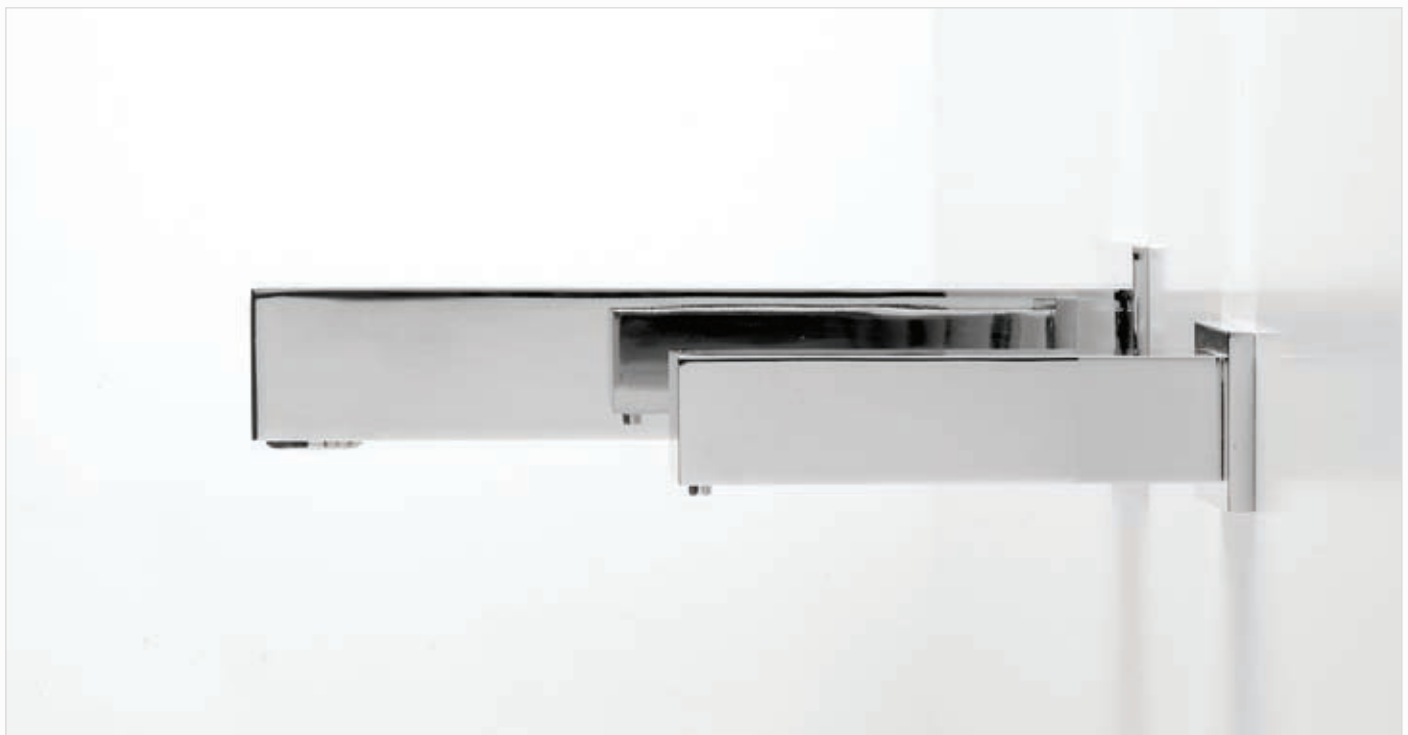

Advantages:

- Drastically reduces soap consumption
- No physical contact. Helps to protect users against cross contamination.
- Peristaltic pump. The soap is driven inside the soap tube without contact with the pump, preventing contamination and back flow.
- Accurate soap dosage
- To be used with non-proprietary soap for maximum savings.
- Soap dosage adjustable by remote control
- Easy to install and refill
- Matching IR operated faucet



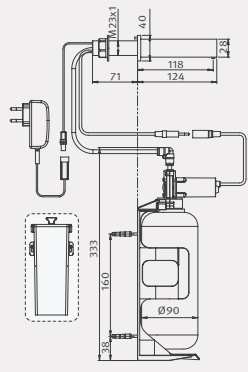

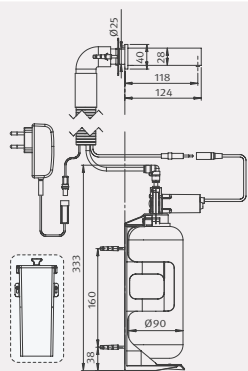
## SOAP DISPENSER VERSIONS

PICTURE	PRODUCT NAME	MODEL FEATURES	POWER SUPPLY	CODE NUMBER	DRAWING
	<b>QUADRAT SOAP DISPENSER B</b>	Standard	Battery box for 6D batteries	<b>351910</b>	
	<b>QUADRAT SOAP DISPENSER E</b>		12V Transformer	<b>351900</b>	
	<b>QUADRAT SOAP DISPENSER 2030 B</b>	Concealed installation	Battery box for 6D batteries	<b>351920</b>	
	<b>QUADRAT SOAP DISPENSER 2030 E</b>		12V Transformer	<b>351930</b>	

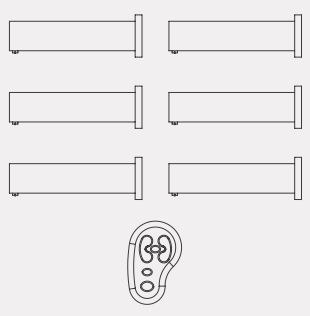
## 6-PACK SOAP DISPENSER VERSIONS

PRODUCT NAME	MODEL FEATURES	POWER SUPPLY	CODE NUMBER	DRAWING
<b>QUADRAT SD B 6-PACK</b>	Packaging includes 6 individual soap dispenser units and 1 remote control	Battery box for 6D batteries	<b>351911</b>	
<b>QUADRAT SD E 6-PACK</b>		12V Transformer	<b>351901</b>	
<b>QUADRAT 2030 SD B 6-PACK</b>		Battery box for 6D batteries	<b>351921</b>	
<b>QUADRAT 2030 SD E 6-PACK</b>		12V Transformer	<b>351931</b>	

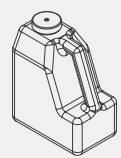
## SOAP DISPENSER ACCESSORIES

PRODUCT NAME	MODEL FEATURES	CODE NUMBER	DRAWING
<b>5L TANK KIT for individual soap dispenser</b>	5 liters tank kit to be used with an individual soap dispenser. Ideal for locations with only one soap dispenser and non frequent servicing	<b>07220097</b>	
<b>REMOTE CONTROL FOR SD</b>	Allows changing: soap quantity, temporary off function, back to soap factory settings, refill the soap tank	<b>07100008</b>	

# BEHIND MIRROR SD

TOUCH FREE ELECTRONIC SOAP DISPENSER UNIT TO BE INTEGRATED BEHIND THE MIRROR

**Advantages:**

- Drastically reduces soap consumption
- No physical contact. Helps to protect users against cross contamination.
- Peristaltic pump. The soap is driven inside the soap tube without contact with the pump, preventing contamination and back flow.
- Accurate soap dosage
- To be used with non-proprietary soap for maximum savings.
- Soap dosage adjustable by remote control
- Easy to install and refill
- Matching IR operated faucet



## SOAP DISPENSER VERSIONS

PICTURE	PRODUCT NAME	MODEL FEATURES	POWER SUPPLY	CODE NUMBER	DRAWING
	BEHIND MIRROR SD B	Standard	Battery box for 6D batteries	280210	
	BEHIND MIRROR SD E		12V Transformer	280200	

## SOAP DISPENSER ACCESSORIES

PRODUCT NAME	MODEL FEATURES	CODE NUMBER	DRAWING
REMOTE CONTROL FOR SD	Allows changing: soap quantity, temporary off function, back to soap factory settings, refill the soap tank	07100008	

# TUBULAR FOAM SD

WALL MOUNTED TOUCH FREE ELECTRONIC SOAP DISPENSER FOR FOAMING NON-PROPRIETARY SOAP

Advantages:

- Drastically reduces soap consumption
- No physical contact. Helps to protect users against cross contamination.
- Peristaltic pump. The soap is driven inside the soap tube without contact with the pump, preventing contamination and back flow.
- Accurate soap dosage
- To be used with non-proprietary soap for maximum savings.
- Soap dosage and air to increase soap “foamability” adjustable by remote control
- Easy to install and refill
- Matching IR operated faucet

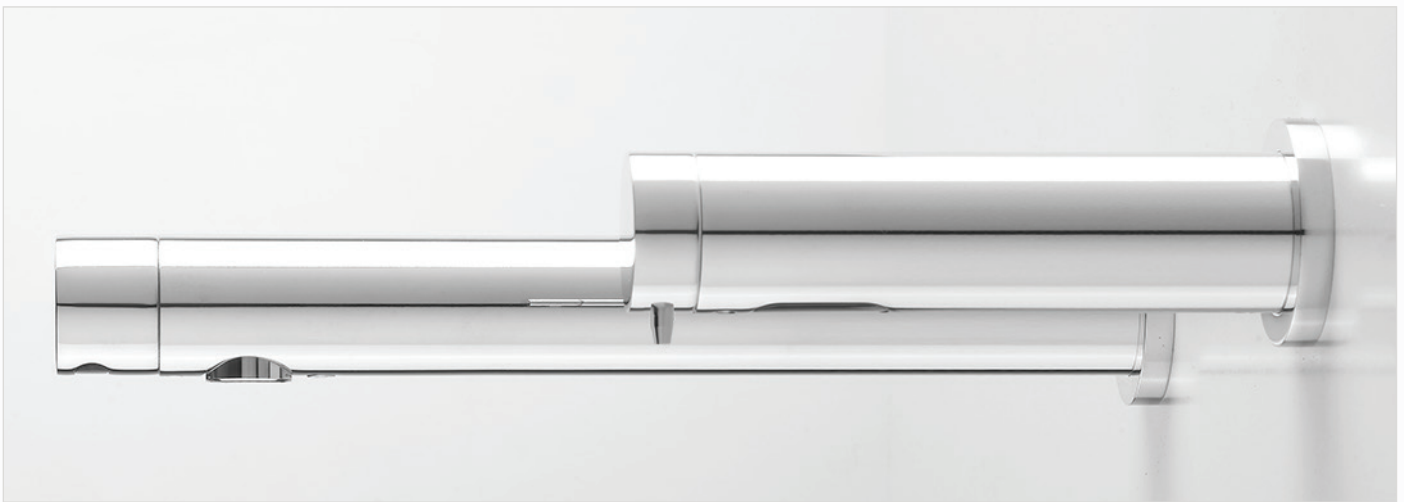

## SOAP DISPENSER VERSIONS

PICTURE	PRODUCT NAME	POWER SUPPLY	CODE NUMBER	DRAWING
	TUBULAR FOAM E	12V Transformer	350980	

## SOAP DISPENSER ACCESSORIES

PRODUCT NAME	MODEL FEATURES	CODE NUMBER	DRAWING
REMOTE CONTROL FOR FOAM SD	Allows changing: Soap quantity, air amount for more foam ability, Back to factory settings and priming fill of the soap tank	07100009	

# FOAM SOAP DISPENSERS





DECK MOUNTED TOUCH FREE ELECTRONIC SOAP DISPENSER FOR FOAMING NON-PROPRIETARY SOAP

Advantages:

- Drastically reduces soap consumption
- No physical contact. Helps to protect users against cross contamination.
- Peristaltic pump. The soap is driven inside the soap tube without contact with the pump, preventing contamination and back flow.
- Accurate soap dosage
- To be used with non-proprietary soap for maximum savings.
- Soap dosage and air to increase soap "foamability" adjustable by remote control
- Easy to install and refill
- Matching IR operated faucet

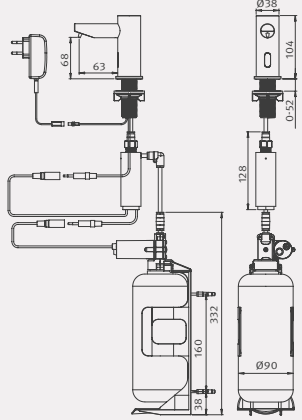

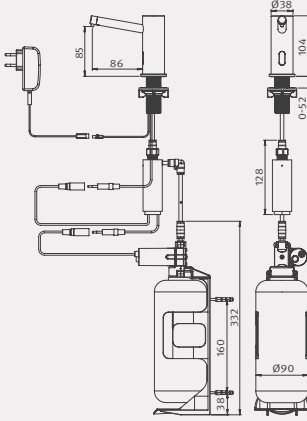
## SOAP DISPENSER VERSIONS

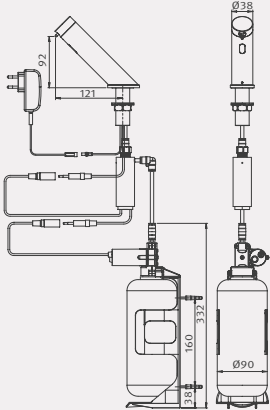
PICTURE	PRODUCT NAME	POWER SUPPLY	CODE NUMBER	DRAWING
	TRENDY FOAM E	12V Transformer	239930	
	ELITE FOAM E	12V Transformer	236120	
	GREEN FOAM E	12V Transformer	225842	

## SOAP DISPENSER ACCESSORIES

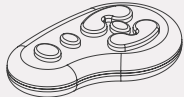
PRODUCT NAME	MODEL FEATURES	CODE NUMBER	DRAWING
<b>REMOTE CONTROL FOR FOAM SD</b>	Allows changing: Soap quantity, air amount for more foam ability, Back to factory settings and priming fill of the soap tank.	07100009	

## MULTIFEED KITS

### KIT FOR MULTIPLE SOAP DISPENSERS INSTALLATION

Allows to install up to 6 soap dispensers together to be feeded simultaneously from the 5 liters tank, that includes a stainless steel support. In addition anti-theft top filling mechanism to easily refill the soap from the top.

Advantages:

- Feeds up to 6 soap dispenser simultaneously
- Vandal resistant top filling mechanism option for easy refill
- Soap level indicator option
- Stainless steel 5 liters tank support











PRODUCT NAME	MODEL FEATURES	CODE NUMBER	DRAWING
<p><b>TOP FILLING MULTIFEED KIT</b></p>	<p>Vandal resistant chrome plated brass top filling mechanism. Available for transformer MF versions</p>	<p>07220090</p>	
<p><b>TOP FILLING MULTIFEED KIT WITH SOAP LEVEL INDICATOR</b></p>	<p>Vandal resistant chrome plated brass top filling mechanism with LED indicator. Available for transformer versions. Supplied with power splitter to be connected to the MF soap dispenser transformer</p> <p>TO BE LAUNCHED IN FALL 2015</p>	<p>07220152</p>	
<p><b>MULTIFEED KIT WITHOUT TOP FILLING</b></p>	<p>For multiple soap dispensers installation without possibility to drill a hole at the deck. Available for transformer MF versions</p>	<p>07220096</p>	



# MULTIPLE FEED MATCHING SOAP DISPENSERS

## DECK MOUNTED TOUCH FREE ELECTRONIC SOAP DISPENSER FOR DISPENSER FOR MULTIFEED SYSTEM

PRODUCT NAME	POWER SUPPLY	CODE NUMBER	DRAWING
MF TRENDY SOAP DISPENSER	12V Transformer	07292073	
MF TRENDY PLUS SOAP DISPENSER	12V Transformer	07292099	
MF EXTREME SOAP DISPENSER	12V Transformer	07292056	
MF EXTREME PLUS SOAP DISPENSER	12V Transformer	07292095	
MF ELITE SOAP DISPENSER	12V Transformer	07292077	
MF ELITE PLUS SOAP DISPENSER	12V Transformer	07292095	
MF GREEN SOAP DISPENSER	12V Transformer	07292062	
MF GREEN 28 SOAP DISPENSER	12V Transformer	07292062	
MF SWAN SOAP DISPENSER	12V Transformer	07292117	

## WALL MOUNTED TOUCH FREE ELECTRONIC SOAP DISPENSER FOR DISPENSER FOR MULTIFEED SYSTEM

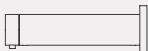
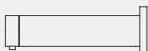
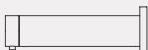
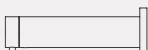
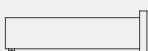
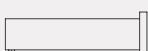
PRODUCT NAME	POWER SUPPLY	CODE NUMBER	DRAWING
MF TUBULAR SOAP DISPENSER	12V Transformer	07292081	
MF TUBULAR SOAP 2030 DISPENSER	12V Transformer	07292076	
MF TUBULAR PROX SOAP DISPENSER	12V Transformer	07292081	
MF TUBULAR PROX 2030 SOAP DISPENSER	12V Transformer	07292095	
MF QUADRAT SOAP DISPENSER	12V Transformer	07292078	
MF QUADRAT 2030 SOAP DISPENSER	12V Transformer	07292094	

**CHROME PLATED FULL BRASS  
LOCKABLE COVER**

**MF TOUCH FREE  
SOAP DISPENSER**

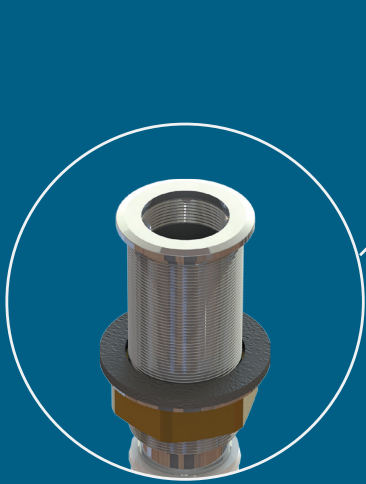

**CHROME PLATED FULL BRASS TOP  
FILLING MECHANISM**



**PERISTALTIC PUMP  
(PART OF THE MF SOAP DISPENSER)**

**FLEXIBLE INTAKE PIPE**

**SOAP COVER WITH UP TO 6 PIPES**



**12V TRANSFORMER**



**POWER SPLITTER SOAP & WATER**

**5 LITERS SOAP TANK WITH  
STAINLESS STEEL SUPPORT**

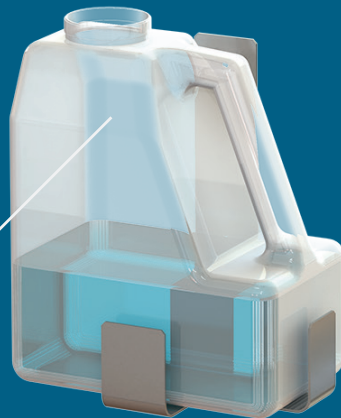

**TOP FILLING MULTIFEED KIT**